

1 2 3 4 5 6

A  
B  
C  
D  
E

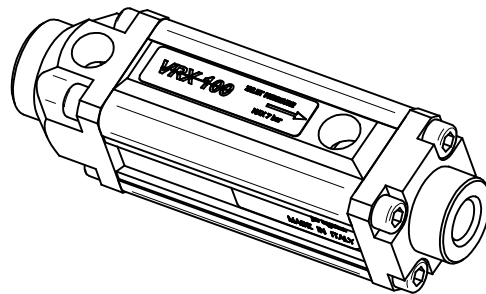

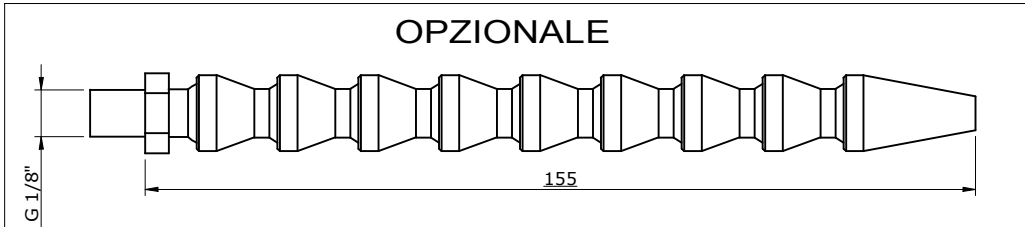
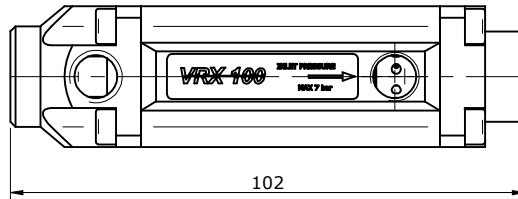
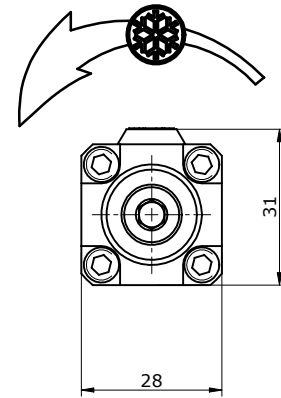
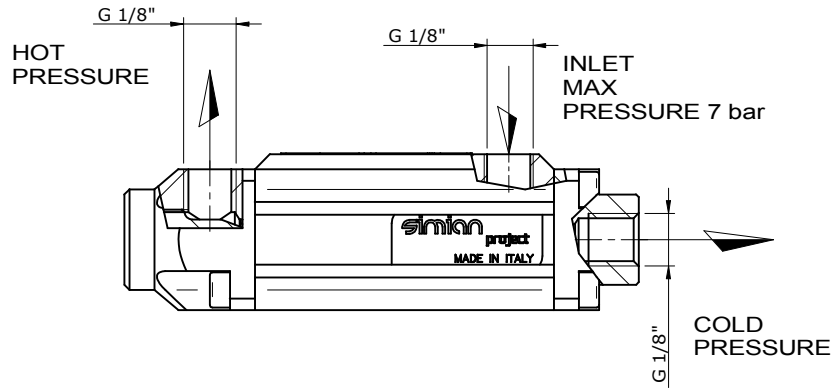
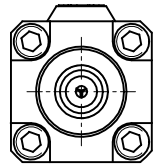

**TABELLA PRESTAZIONI CONSUMI**  
con temperatura in ingresso 20° C

Pressione (Bar)	Temp. Uscita Fraz. fredda (°C)	Consumo aria (NL/min)	----- Potenza di raffreddamento (W - Kcal/h - BTU/h)
1	-2	32	
2	-12	53	
3	-18	74	
4	-23	94	
5	-26	115	
6	-28	135	
7	-31	154	132 W - 110 kcal/h - 440 BTU/h



simianproject.com

<b>SCHEDA TECNICA PRODOTTO</b>		DATA/DATE	
		12/07/2017	
RAFFREDDATORE VRX0100		AUTORE/AUTHOR	
		L.Lombardi	
		PESO/WEIGHT	SCALA/SCALE
		0.000 kg	1:1
		EDDICE/CODE	REV.
		90VRX0100-S	00